

Tube Adapter Ring for Mini LED Downlights

SKU: 11.0992.038.26

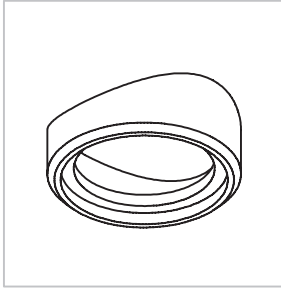

Options:



Material: Stainless Steel AISI 304

Weight: ca. 0.05 kg

Finish: Anthracite Design

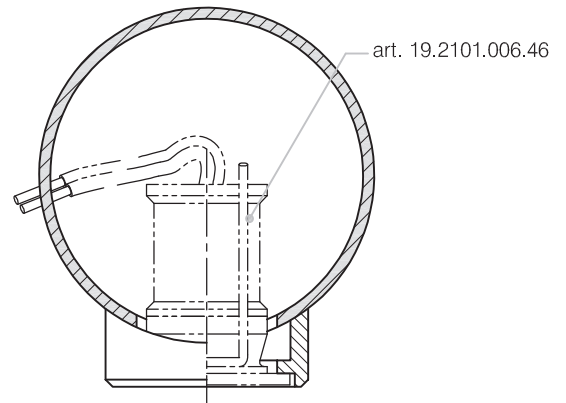
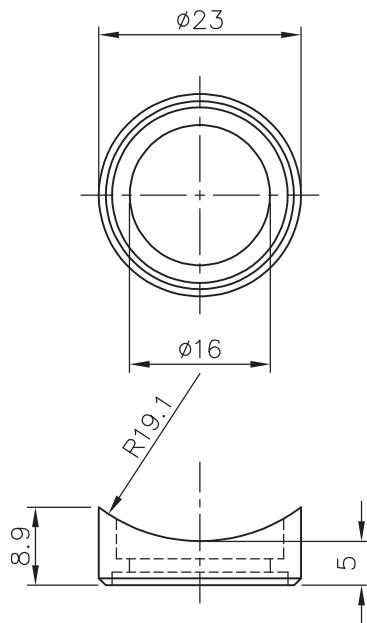

Installation

